

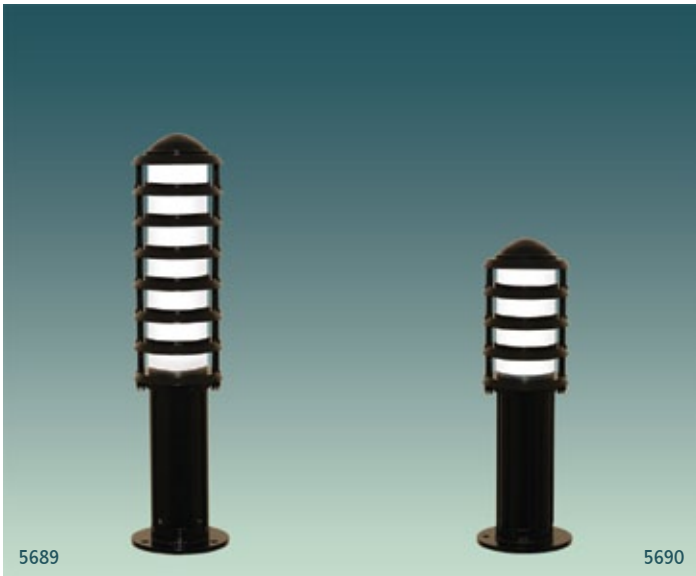

ID	DESCRIPTION	DIMENSION mm	PRICE Rs.
MEXICAN SLIMMY			
5687	Ⓜ Single 11W CFL Integral Translucent Slim	Ø 94 x 400	3260/-
5688	Ⓜ Single 18W CFLC Integral Translucent Slim	Ø 94 x 318	2540/-

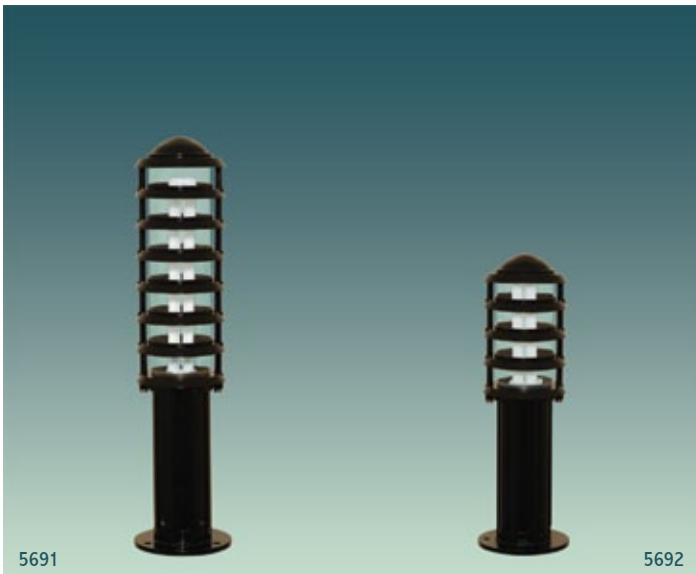

5689	Ⓜ Single 11W CFL Integral Translucent Slim	Ø 94 x 400	4460/-
5690	Ⓜ Single 18W CFLC Integral Translucent Slim	Ø 94 x 318	3740/-



5691	Ⓜ Single 11W CFL Integral Louvre Clear Slim	Ø 94 x 400	4460/-
5692	Ⓜ Single 18W CFLC Integral Louvre Clear Slim	Ø 94 x 318	3740/-

NOTE : Ⓜ Mounting Details as per Fig. - 9 in Page No. F1. CFL : Compact Fluorescent Lamp. CFLC : Compact Fluorescent Lamp Coupled.

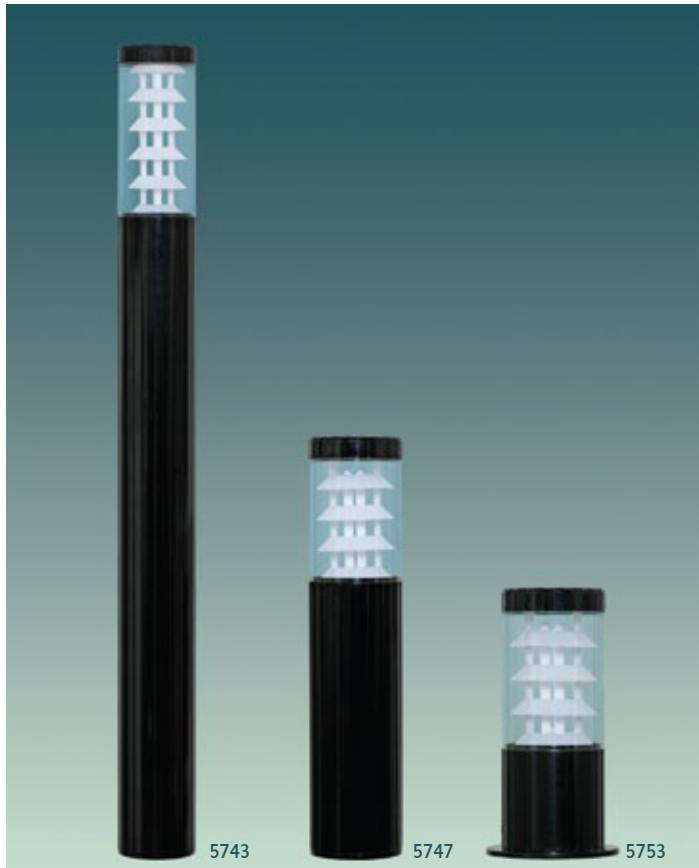
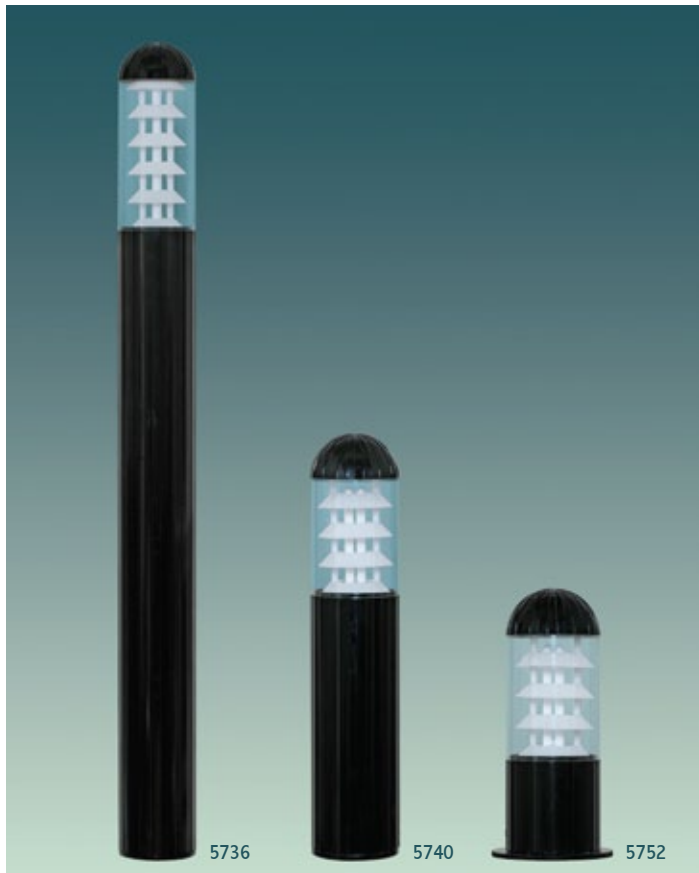

ID	DESCRIPTION	DIMENSION mm	PRICE Rs.
SLEEK BOLLARD - ROUND TOP			
5736	Ⓢ Single 11W CFL Integral Louvre Sleek	Ø 100 x 1065	7400/-
5737	Ⓢ Single 18W CFLC Integral Louvre Sleek	Ø 100 x 1000	6700/-
5739	Ⓢ Single 11W CFL Integral Louvre Small Sleek	Ø 100 x 540	6600/-
5740	Ⓢ Single 18W CFLC Integral Louvre Small Sleek	Ø 100 x 475	5900/-
SLEEK PIAZZA - ROUND TOP			
5752	Ⓢ Single 18W CFLC Integral Louvre Piazza Sleek	Ø 130 x 280	4740/-

SLEEK BOLLARD - FLAT TOP			
5743	Ⓢ Single 11W CFL Integral Louvre Sleek	Ø 100 x 1040	7400/-
5744	Ⓢ Single 18W CFLC Integral Louvre Sleek	Ø 100 x 980	6700/-
5746	Ⓢ Single 11W CFL Integral Louvre Small Sleek	Ø 100 x 515	6600/-
5747	Ⓢ Single 18W CFLC Integral Louvre Small Sleek	Ø 100 x 455	5900/-
SLEEK PIAZZA - FLAT TOP			
5753	Ⓢ Single 18W CFLC Integral Louvre Piazza Sleek	Ø 130 x 260	4740/-

NOTE : Ⓢ Mounting Details as per Fig. - 1 in Page No. F1. Ⓢ Mounting Details as per Fig. - 3 in Page No. F1. CFL : Compact Fluorescent Lamp. CFLC : Compact Fluorescent Lamp Coupled.

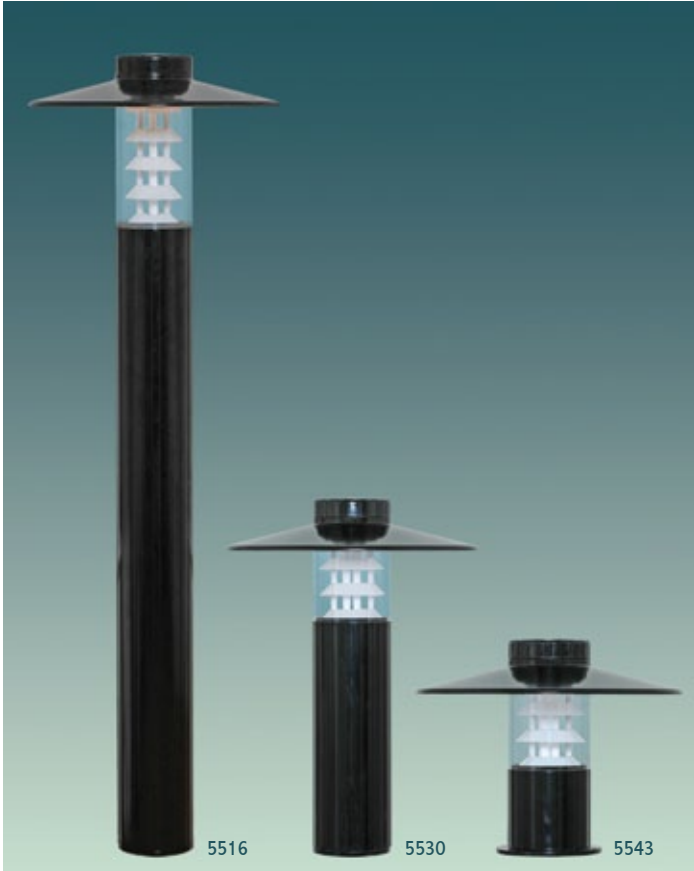

ID	DESCRIPTION	DIMENSION mm	PRICE Rs.
BEACON BOLLARD - SINGLE REFLECTOR			
5516	Ⓜ Single 11W CFL Integral Louvre Sleek TPR	Ø 325 x 1040	7870/-
5517	Ⓜ Single 18W CFLC Integral Louvre Sleek TPR	Ø 325 x 980	7170/-
5529	Ⓜ Single 11W CFL Integral Louvre Small Sleek TPR	Ø 325 x 515	7070/-
5530	Ⓜ Single 18W CFLC Integral Louvre Small Sleek TPR	Ø 325 x 455	6370/-
BEACON PIAZZA - SINGLE REFLECTOR			
5543	Ⓜ Single 18W CFLC Integral Louvre Piazza Sleek TPR	Ø 325 x 260	5210/-

BEACON BOLLARD - DOUBLE REFLECTOR			
5523	Ⓜ Single 11W CFL Integral Louvre Sleek TPDR	Ø 325 x 1090	8290/-
5536	Ⓜ Single 11W CFL Integral Louvre Sleek Small TPDR	Ø 325 x 565	7490/-
BEACON PIAZZA - DOUBLE REFLECTOR			
5548	Ⓜ Single 11W CFL Integral Louvre Piazza Sleek TPDR	Ø 325 x 380	6330/-

NOTE : CFL : Compact Fluorescent Lamp. CFLC : Compact Fluorescent Lamp Coupled. TPR : Tapered Reflector. TPDR : Tapered Double Reflector.
 Ⓜ Mounting Details as per Fig. - 1 in Page No. F1. Ⓜ Mounting Details as per Fig. - 3 in Page No. F1.

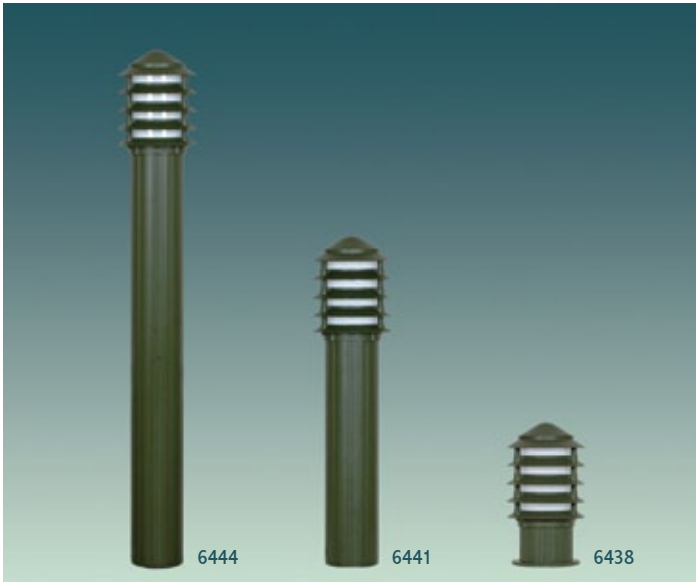

ID	DESCRIPTION	DIMENSION mm	PRICE Rs.
MEXICAN BOLLARD - PYRO TOP			
6444	Ⓜ Single 18W CFLC Integral ✦	Ø 148 x 990	8640/-
6441	Ⓜ Single 18W CFLC Integral Small ✦	Ø 148 x 460	7840/-
MEXICAN PIAZZA - PYRO TOP			
6438	Ⓜ Single 18W CFLC Integral ✦	Ø 148 x 270	6680/-

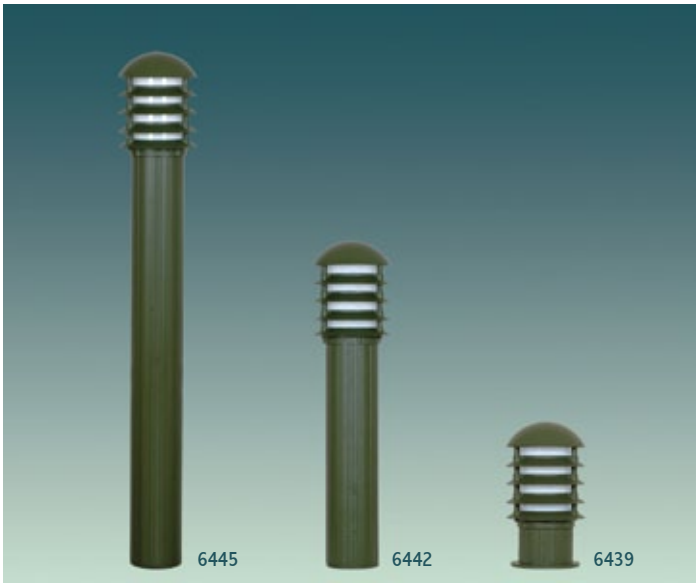

MEXICAN BOLLARD - ROUND TOP			
6445	Ⓜ Single 18W CFLC Integral ✦	Ø 148 x 990	8640/-
6442	Ⓜ Single 18W CFLC Integral Small ✦	Ø 148 x 460	7840/-
MEXICAN PIAZZA - ROUND TOP			
6439	Ⓜ Single 18W CFLC Integral ✦	Ø 148 x 270	6680/-

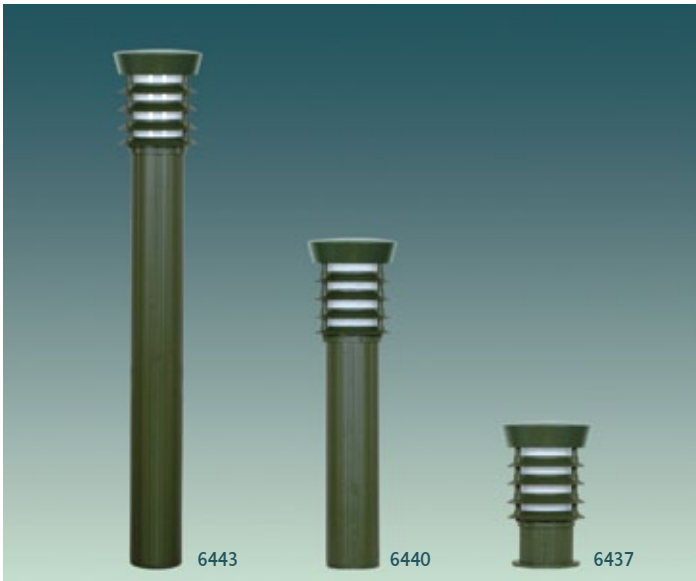

MEXICAN BOLLARD - FLAT TOP			
6443	Ⓜ Single 18W CFLC Integral ✦	Ø 168 x 990	9240/-
6440	Ⓜ Single 18W CFLC Integral Small ✦	Ø 168 x 460	8440/-
MEXICAN PIAZZA - FLAT TOP			
6437	Ⓜ Single 18W CFLC Integral ✦	Ø 168 x 270	7280/-

NOTE : CFLC : Compact Fluorescent Lamp Coupled. ✦ For 11W CFL Add Rs. 300/- extra and add height by 30mm.
 Ⓜ Mounting Details as per Fig. - 1 in Page No. F1. Ⓜ Mounting Details as per Fig. - 3 in Page No. F1.

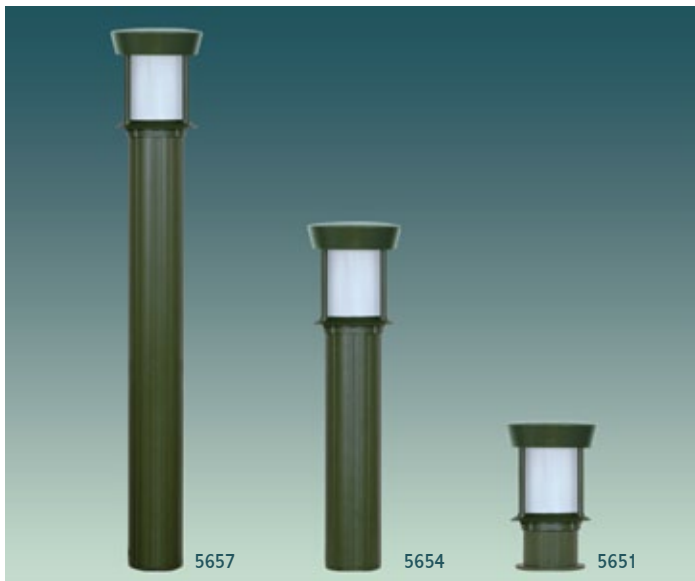

ID	DESCRIPTION	DIMENSION mm	PRICE Rs.
MEXICAN MAYA BOLLARD - PYRO TOP			
5658	Ⓜ Single 18W CFLC Integral ✦	Ø 148 x 990	7550/-
5655	Ⓜ Single 18W CFLC Integral Small ✦	Ø 148 x 460	6750/-
MEXICAN MAYA PIAZZA - PYRO TOP			
5652	Ⓜ Single 18W CFLC Integral ✦	Ø 148 x 270	5590/-
MEXICAN MAYA BOLLARD - ROUND TOP			
5659	Ⓜ Single 18W CFLC Integral ✦	Ø 148 x 990	7550/-
5656	Ⓜ Single 18W CFLC Integral Small ✦	Ø 148 x 460	6750/-
MEXICAN MAYA PIAZZA - ROUND TOP			
5653	Ⓜ Single 18W CFLC Integral ✦	Ø 148 x 270	5590/-
MEXICAN MAYA BOLLARD - FLAT TOP			
5657	Ⓜ Single 18W CFLC Integral ✦	Ø 168 x 990	8150/-
5654	Ⓜ Single 18W CFLC Integral Small ✦	Ø 168 x 460	7350/-
MEXICAN MAYA PIAZZA - FLAT TOP			
5651	Ⓜ Single 18W CFLC Integral ✦	Ø 168 x 270	6190/-

NOTE : CFLC : Compact Fluorescent Lamp Coupled. ✦ For 11W CFL Add Rs. 300/- extra and add height by 30mm.
 Ⓜ Mounting Details as per Fig. - 1 in Page No. F1. Ⓜ Mounting Details as per Fig. - 3 in Page No. F1.



ID	DESCRIPTION	DIMENSION mm	PRICE Rs.
MEXICAN AZTEC BOLLARD - PYRO TOP			
5667	Ⓜ Single 18W CFLC Integral Louvre Clear ✦	Ø 148 x 990	7870/-
5664	Ⓜ Single 18W CFLC Integral Louvre Clear Small ✦	Ø 148 x 460	7070/-

MEXICAN AZTEC PIAZZA - PYRO TOP			
5661	Ⓜ Single 18W CFLC Integral Louvre Clear ✦	Ø 148 x 270	5910/-



MEXICAN AZTEC BOLLARD - ROUND TOP			
5668	Ⓜ Single 18W CFLC Integral Louvre Clear ✦	Ø 148 x 990	7870/-
5665	Ⓜ Single 18W CFLC Integral Louvre Clear Small ✦	Ø 148 x 460	7070/-

MEXICAN AZTEC PIAZZA - ROUND TOP			
5662	Ⓜ Single 18W CFLC Integral Louvre Clear ✦	Ø 148 x 270	5910/-



MEXICAN AZTEC BOLLARD - FLAT TOP			
5666	Ⓜ Single 18W CFLC Integral Louvre Clear ✦	Ø 168 x 990	8470/-
5663	Ⓜ Single 18W CFLC Integral Louvre Clear Small ✦	Ø 168 x 460	7670/-

MEXICAN AZTEC PIAZZA - FLAT TOP			
5660	Ⓜ Single 18W CFLC Integral Louvre Clear ✦	Ø 168 x 270	6510/-

NOTE : CFLC : Compact Fluorescent Lamp Coupled. ✦ For 11W CFL Add Rs. 300/- extra and add height by 30mm.
 Ⓜ Mounting Details as per Fig. - 1 in Page No. F1. Ⓜ Mounting Details as per Fig. - 3 in Page No. F1.



ID	DESCRIPTION	DIMENSION mm	PRICE Rs.
HYBRID BOLLARD - PYRO TOP			
5676	Ⓜ Single 18W CFLC Integral ✦	Ø 325 x 990	8750/-
5673	Ⓜ Single 18W CFLC Integral Small ✦	Ø 325 x 460	7950/-

HYBRID PIAZZA - PYRO TOP			
5670	Ⓜ Single 18W CFLC Integral ✦	Ø 325 x 270	6790/-



HYBRID BOLLARD - ROUND TOP			
5677	Ⓜ Single 18W CFLC Integral ✦	Ø 325 x 990	8750/-
5674	Ⓜ Single 18W CFLC Integral Small ✦	Ø 325 x 460	7950/-

HYBRID PIAZZA - ROUND TOP			
5671	Ⓜ Single 18W CFLC Integral ✦	Ø 325 x 270	6790/-



HYBRID BOLLARD - FLAT TOP			
5675	Ⓜ Single 18W CFLC Integral ✦	Ø 325 x 990	9350/-
5672	Ⓜ Single 18W CFLC Integral Small ✦	Ø 325 x 460	8550/-

HYBRID PIAZZA - FLAT TOP			
5669	Ⓜ Single 18W CFLC Integral ✦	Ø 325 x 270	7390/-

NOTE : CFLC : Compact Fluorescent Lamp Coupled. ✦ For 11W CFL Add Rs. 300/- extra and add height by 30mm.

Ⓜ Mounting Details as per Fig. - 1 in Page No. F1. Ⓜ Mounting Details as per Fig. - 3 in Page No. F1.



ID	DESCRIPTION	DIMENSION mm	PRICE Rs.
----	-------------	-----------------	--------------

DUAL REFLECTOR - FLAT TOP

6702	Ⓜ Single 70W (I) HPSV E27 Base Lamp ⚡ 🎵 Ⓞ	Ø 173 x 1080	10500/-
6703	Ⓜ Single 70W MH E27 Base Lamp Integral ⚡ 🎵	Ø 173 x 1080	11240/-
6705	Ⓜ Single 70W (I) HPSV E27 Base Lamp ⚡ Ⓞ	Ø 173 x 555	9700/-
6706	Ⓜ Single 70W MH E27 Base Lamp Integral Small ⚡	Ø 173 x 555	10440/-

PIAZZA MINI

6715	Ⓜ Single 100W GLS Lamp Round Top DR	Ø 195 x 205	3860/-
------	-------------------------------------	-------------	--------

PAGODA REFLECTOR - ROUND TOP

6709	Ⓜ Single 70W (I) HPSV E27 Base Lamp ⚡ 🎵 Ⓞ	Ø 165 x 1000	10440/-
6710	Ⓜ Single 70W MH E27 Base Lamp Integral ⚡ 🎵	Ø 165 x 1000	11180/-
6712	Ⓜ Single 70W (I) HPSV E27 Base Lamp ⚡ Ⓞ	Ø 165 x 475	9640/-
6713	Ⓜ Single 70W MH E27 Base Lamp Integral Small ⚡	Ø 165 x 475	10380/-

PIAZZA MINI

6717	Ⓜ Single 100W GLS Lamp Louvre Round Top PR	Ø 195 x 205	3800/-
5731	Ⓜ Single 20W CFLE Round Top Non-Integral PR	Ø 195 x 280	4320/-
5732	Ⓜ Single 20W CFLE Flat Top Non-Integral PR	Ø 195 x 270	4320/-

PAGODA REFLECTOR - ROUND TOP

5703	Ⓜ Four 9W CFL Integral 🎵	Ø 165 x 1000	10080/-
5706	Ⓜ Four 9W CFL Integral Small	Ø 165 x 475	9280/-
5712	Ⓜ Single 18W CFLC 🎵	Ø 165 x 1000	9380/-
5716	Ⓜ Single 18W CFLC Integral Small	Ø 165 x 475	8580/-

PAGODA REFLECTOR - FLAT TOP

5726	Ⓜ Four 9W CFL Integral 🎵	Ø 165 x 950	9410/-
5727	Ⓜ Four 9W CFL Integral Small	Ø 165 x 410	8610/-

NOTE : GLS : General Lighting Service. CFL : Compact Fluorescent Lamp. CFLC : Compact Fluorescent Lamp Coupled. CFLE : Compact Fluorescent Lamp with built-in Electronic ballast
 Ⓜ Mounting Details as per Fig. - 2 in page No. F1. Ⓜ Mounting Details as per Fig. - 4 in page No. F1. Ⓞ Suitable for lamp with built-in Ignitor. ⚡ Supplied with super imposed Ignitor.
 HPSV : High Pressure Sodium Vapour Lamp. MH : Metal Halide. DR : Dual Reflector. PR : Pagoda Reflector. ⚡ For External Ignitor to suit SV lamp add Rs.1480/-
 🎵 For Musical Arrangement add Rs.1480/-



5521

ID	DESCRIPTION	DIMENSION mm	PRICE Rs.
BEACON BOLLARD - SINGLE REFLECTOR FLAT TOP			
5521	Ⓜ Single 70W MH E27 Base Lamp Integral ⚡ 🎵	Ø 606 x 950	12740/-



5522

BEACON BOLLARD - SINGLE REFLECTOR FLAT TOP			
5522	Ⓜ Four 11W CFL Integral Louvre Clear 🎵	Ø 606 x 950	12370/-



5527

MEXICAN METRO BOLLARD			
5527	Ⓜ Single 70W MH E27 Base Lamp Integral ⚡ 🎵	Ø 410 x 1110	22180/-

NOTE : CFL : Compact Fluorescent Lamp. MH : Metal Halide.

Ⓜ Mounting Details as per Fig. - 2 in page No. F1. ⚡ Supplied with super imposed Ignitor. 🎵 For Musical Arrangement add Rs.1480/-.



ID	DESCRIPTION	DIMENSION mm	PRICE Rs.
TANWIR MINI			
6751	⊕ Single 70W Metal Halide E27 Base Lamp & Single 70W Metal Halide DE Rx7s Lamp Integral ⊕	320 x 230 x 1200	37280/-



ID	DESCRIPTION	DIMENSION mm	PRICE Rs.
FLAT TOP BOLLARD			
3963	Single 70W MH E27 Base Lamp Integral ⊕	∅ 178 x 800	15760/-

NOTE : ⊕ Supplied with super imposed Ignitor. MH : Metal Halide. DE : Double Ended. ⊕ Mounting Details as per Fig. - 23 in page No. F2.

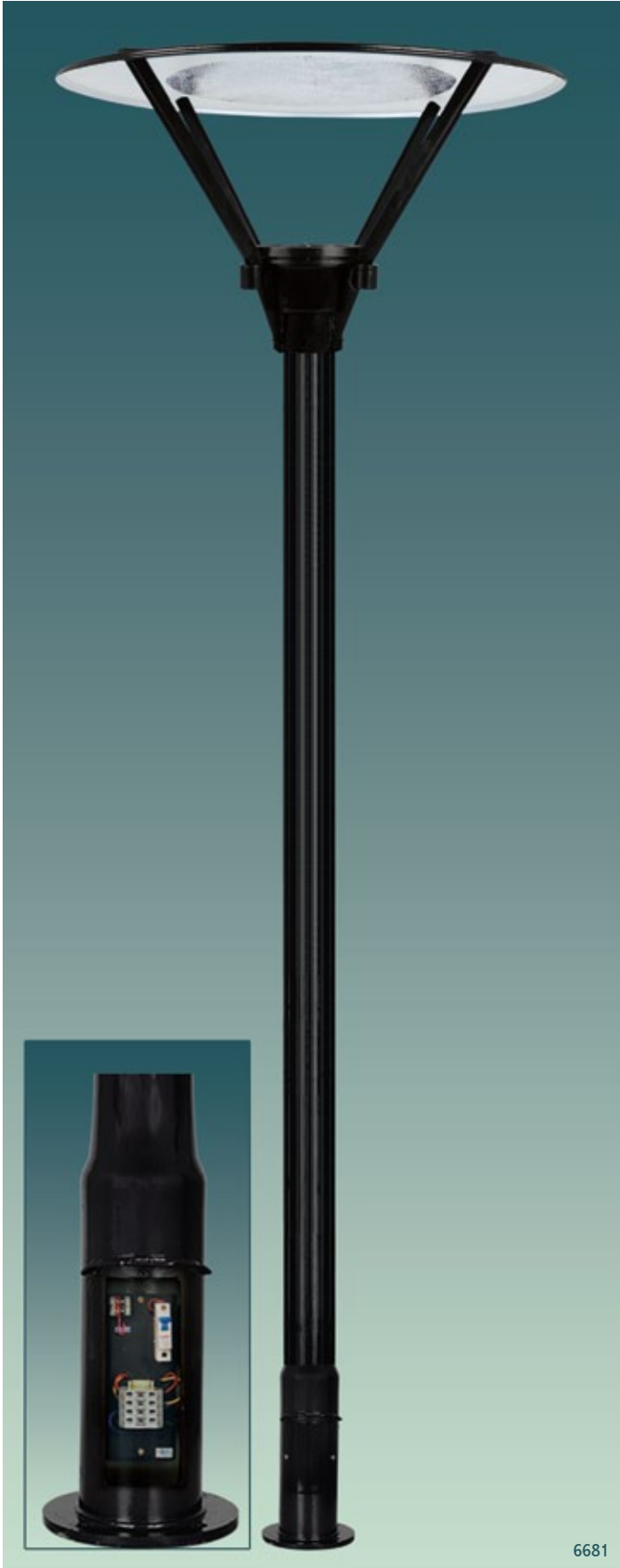

6681

ID	DESCRIPTION	DIMENSION mm	PRICE Rs.
DIXON WITH LOOPIN LOOPOUT BOX			
6681	Ⓜ Single 70W MH DE Lamp Integral ⚡ with Satellite Pole	Ø 765 x 3000	44070/-
6682	Ⓜ Single 150W MH DE Lamp Integral ⚡ with Satellite Pole	Ø 765 x 3000	44960/-
DIXON			
6683	Ⓜ Single 70W MH DE Lamp Integral ⚡ with Satellite Pole	Ø 765 x 3000	39070/-
6684	Ⓜ Single 150W MH DE Lamp Integral ⚡ with Satellite Pole	Ø 765 x 3000	39960/-

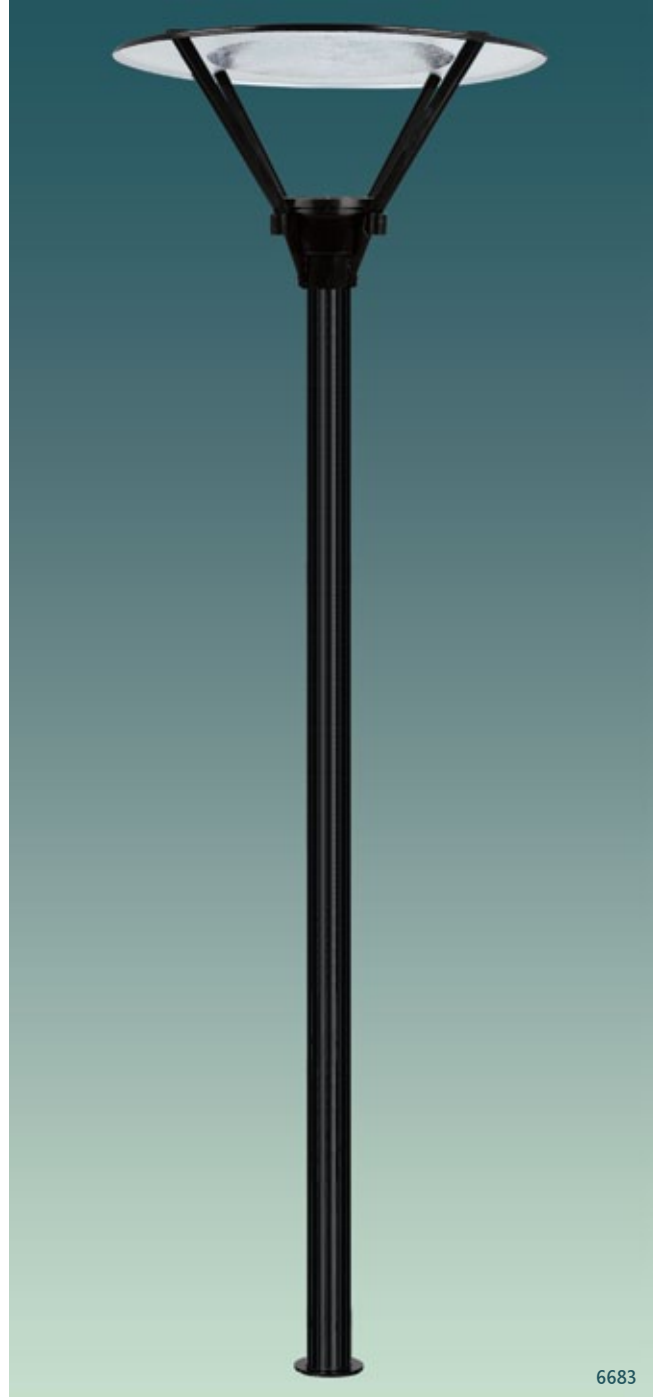

6683

NOTE : MH : Metal Halide. DE : Double Ended. ⚡ Supplied with super imposed Ignitor. Ⓜ Mounting Details as per Fig. - 15 in Page No. F2.
 Ⓜ Mounting Details as per Fig. - 6 in Page No. F1.

ID	DESCRIPTION	DIMENSION mm	PRICE Rs.
SATELLITE GLIDER ASYMMETRIC WITH LOOPIN LOOPOUT BOX			
6654	⊕ Single 70W Metal Halide G12 Base Lamp ⊕ Integral with Satellite Pole	540 x 570 x 3000	29960/-
SATELLITE GLIDER ASYMMETRIC			
6669	⊕ Single 70W Metal Halide G12 Base Lamp ⊕ Integral with Satellite Pole	540 x 570 x 3000	24960/-

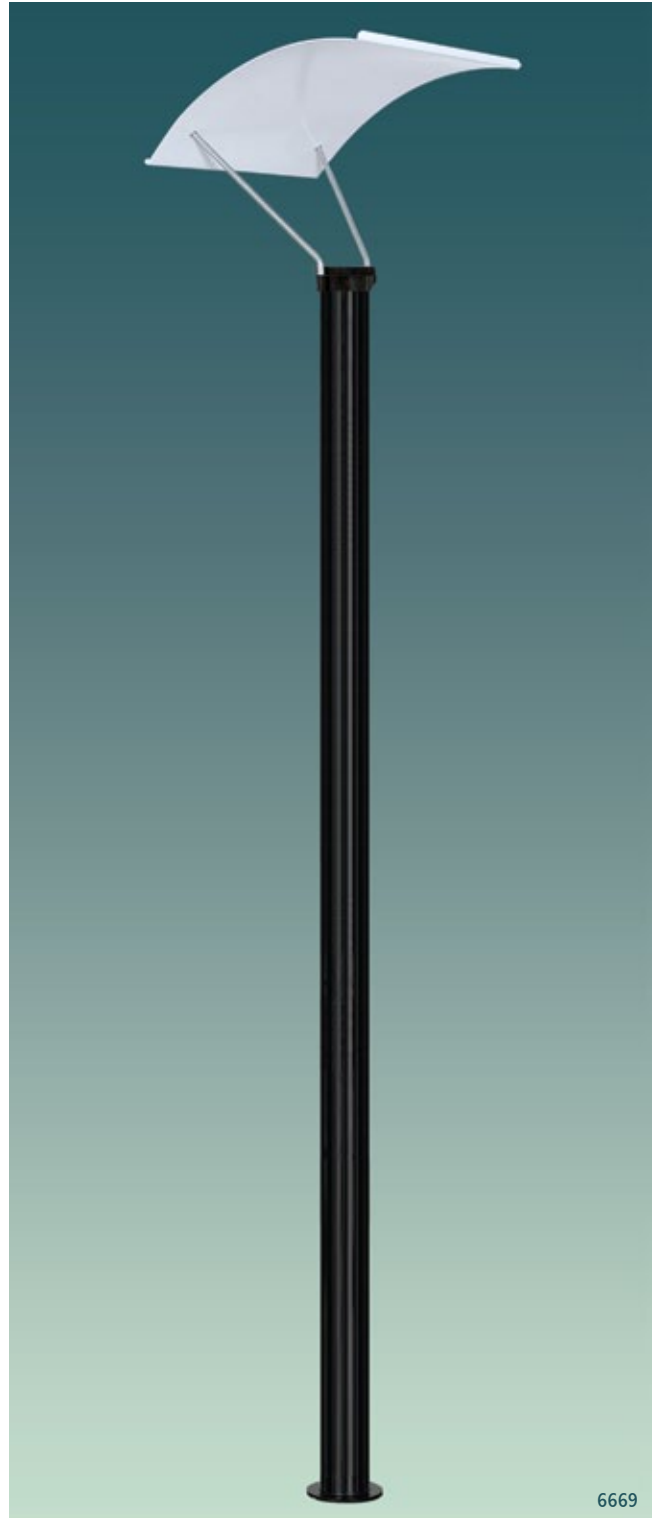
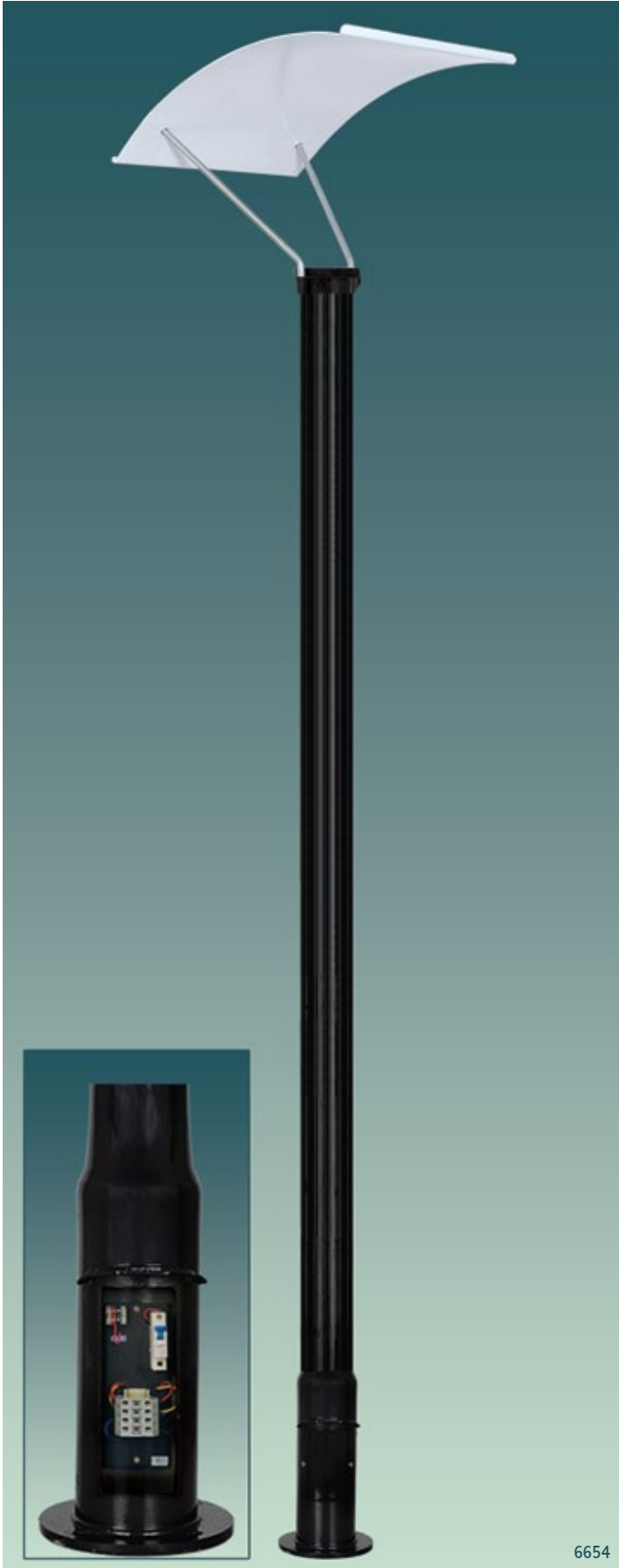

NOTE : ⊕ Supplied with super imposed Ignitor. ⊕ Mounting Details as per Fig. - 15 in Page No. F2. ⊕ Mounting Details as per Fig. - 6 in Page No. F1.

ID	DESCRIPTION	DIMENSION mm	PRICE Rs.
SATELLITE GLIDER SYMMETRIC WITH LOOPIN LOOPOUT BOX			
6667	⊕ Single 70W Metal Halide G12 Base Lamp ⊕ Integral with Satellite Pole	540 x 570 x 3000	29960/-
SATELLITE GLIDER SYMMETRIC			
6666	⊕ Single 70W Metal Halide G12 Base Lamp ⊕ Integral with Satellite Pole	540 x 570 x 3000	24960/-

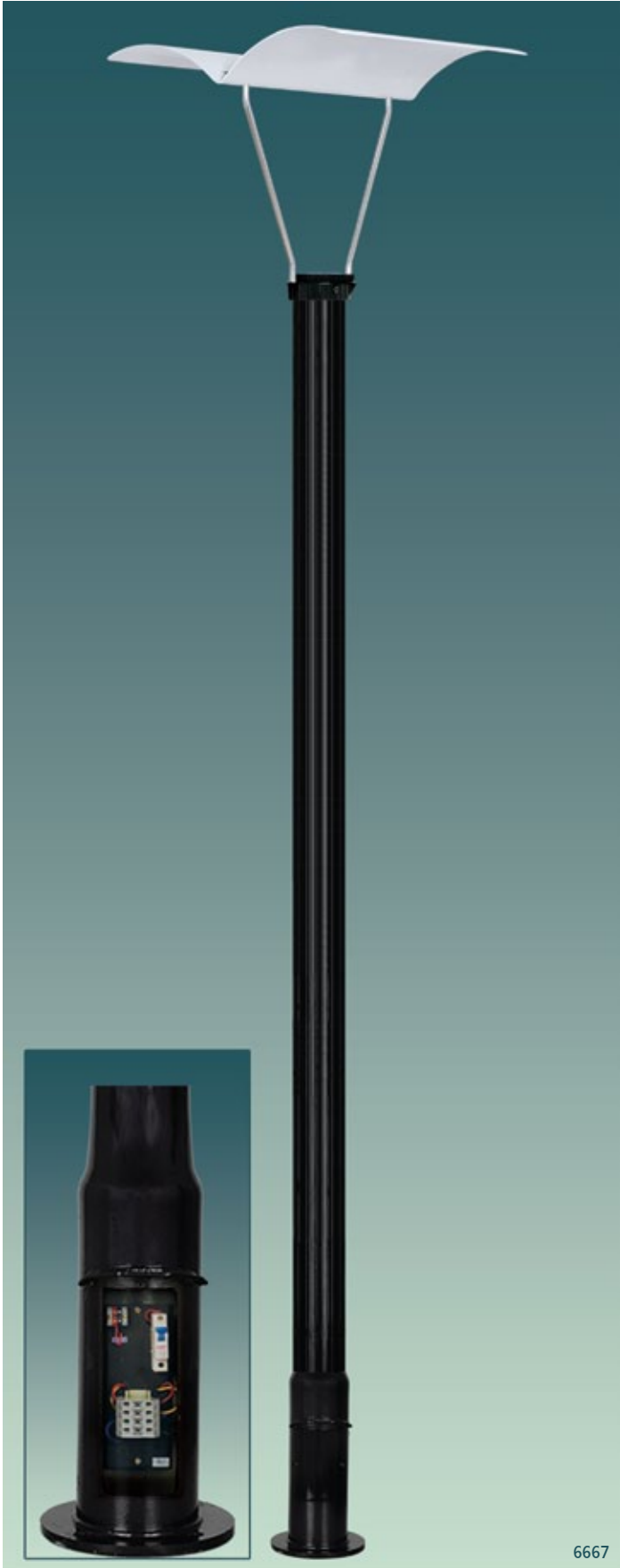

6667

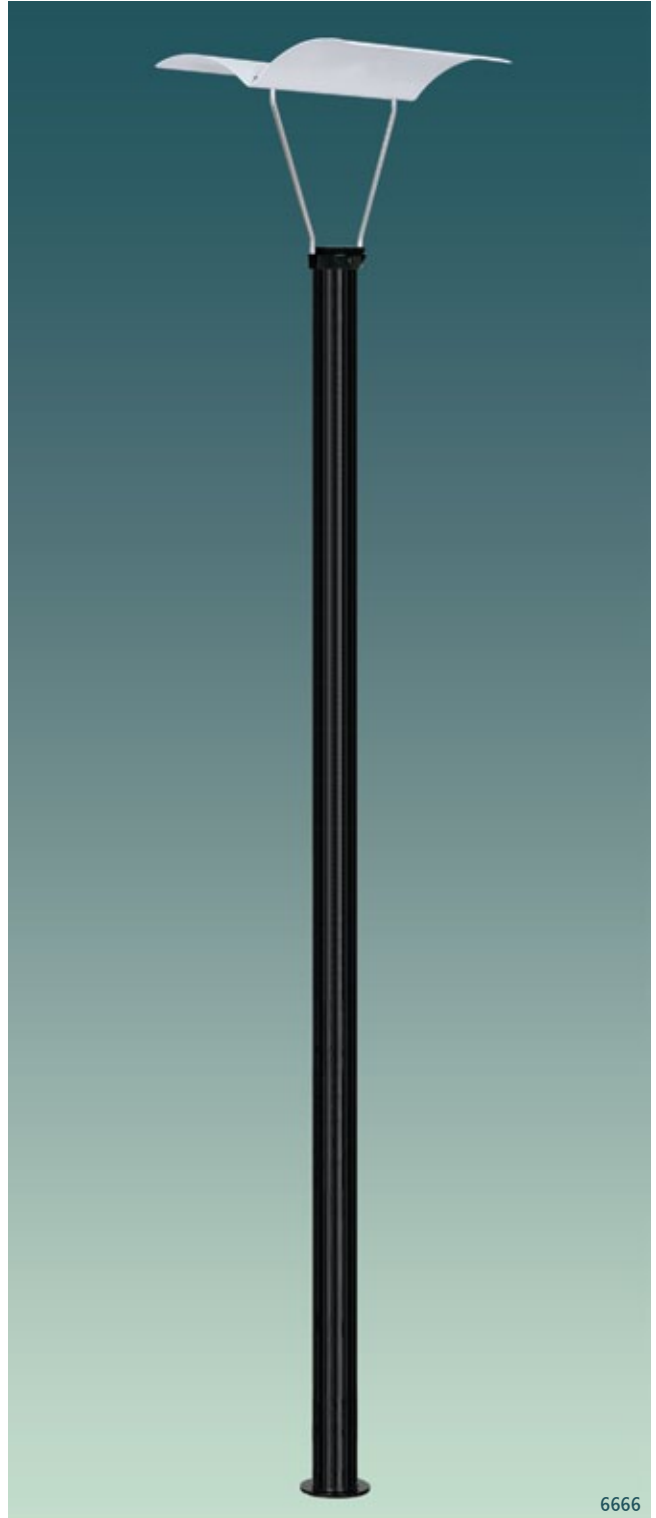

6666

NOTE : ⊕ Supplied with super imposed Ignitor. ⊕ Mounting Details as per Fig. - 15 in Page No. F2. ⊕ Mounting Details as per Fig. - 6 in Page No. F1.

ID	DESCRIPTION	DIMENSION mm	PRICE Rs.
SATELLITE UMBRELLYA WITH LOOPIN LOOPOUT BOX			
6653	⊕ Single 70W Metal Halide G12 Base Lamp ⊕ Integral with Satellite Pole	Ø 590 x 3000	30960/-
SATELLITE UMBRELLYA			
6619	⊕ Single 70W Metal Halide G12 Base Lamp ⊕ Integral with Satellite Pole	Ø 590 x 3000	25960/-

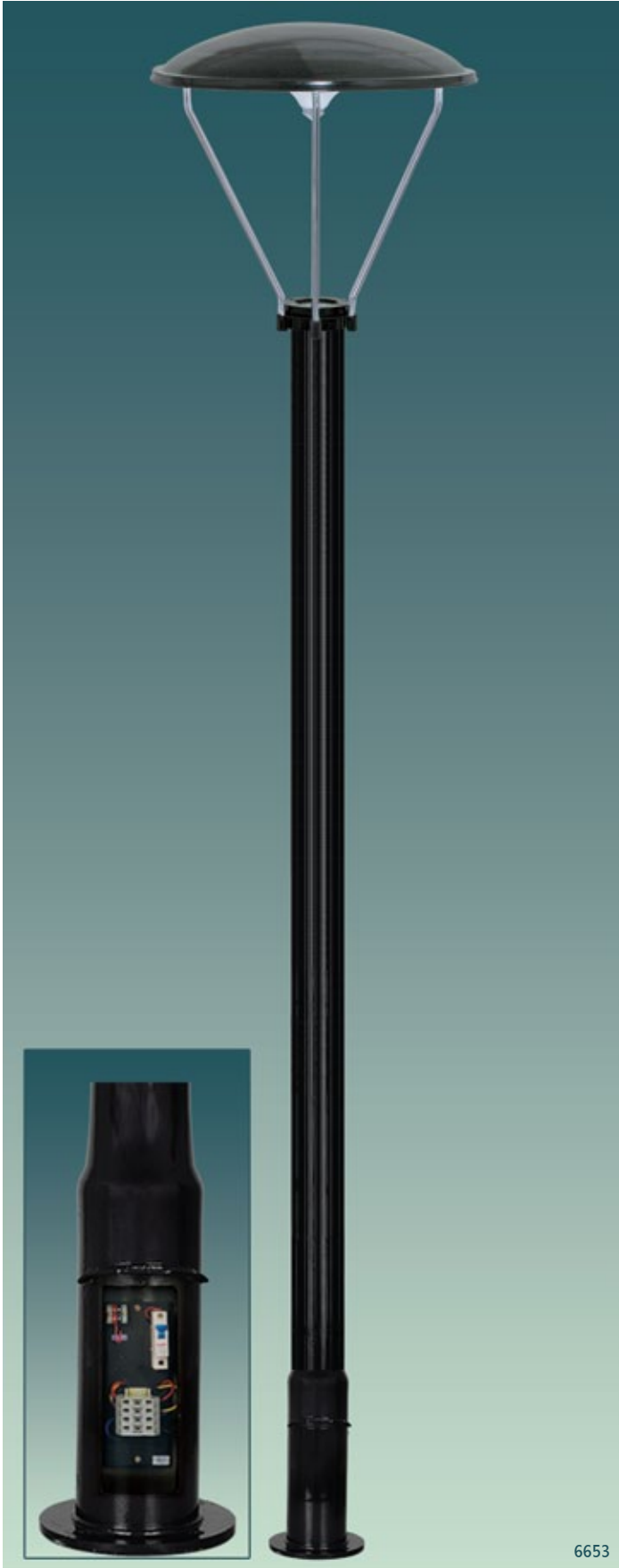

6653

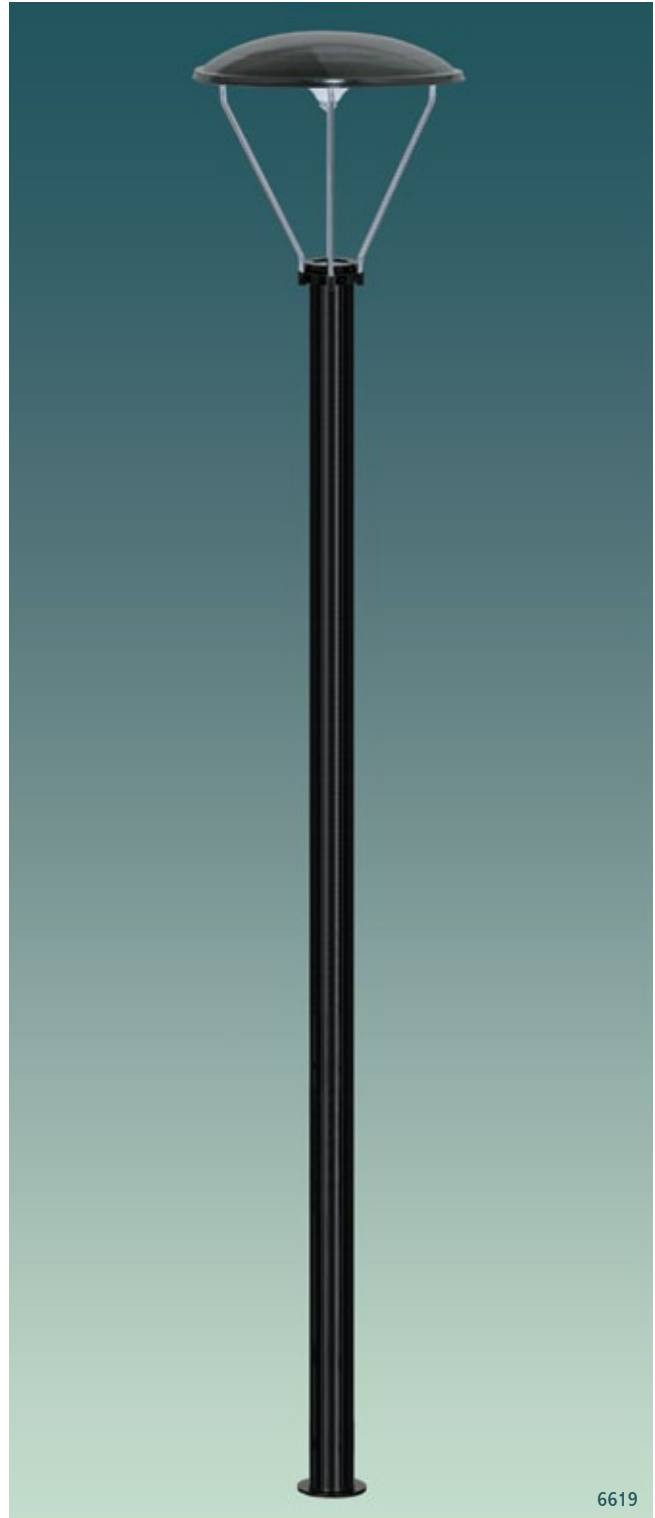

6619

NOTE : ⊕ Supplied with super imposed Ignitor. ⊕ Mounting Details as per Fig. - 15 in Page No. F2. ⊕ Mounting Details as per Fig. - 6 in Page No. F1.

ID	DESCRIPTION	DIMENSION mm	PRICE Rs.
SATELLITE REFLECTO PARACHUTE WITH LOOPIN LOOPOUT BOX			
6674	Ⓢ Single 70W Metal Halide G12 Base Lamp ⚡ Integral with Satellite Pole	Ø 618 x 3000	30960/-
SATELLITE REFLECTO PARACHUTE			
6673	Ⓢ Single 70W Metal Halide G12 Base Lamp ⚡ Integral with Satellite Pole	Ø 618 x 3000	25960/-

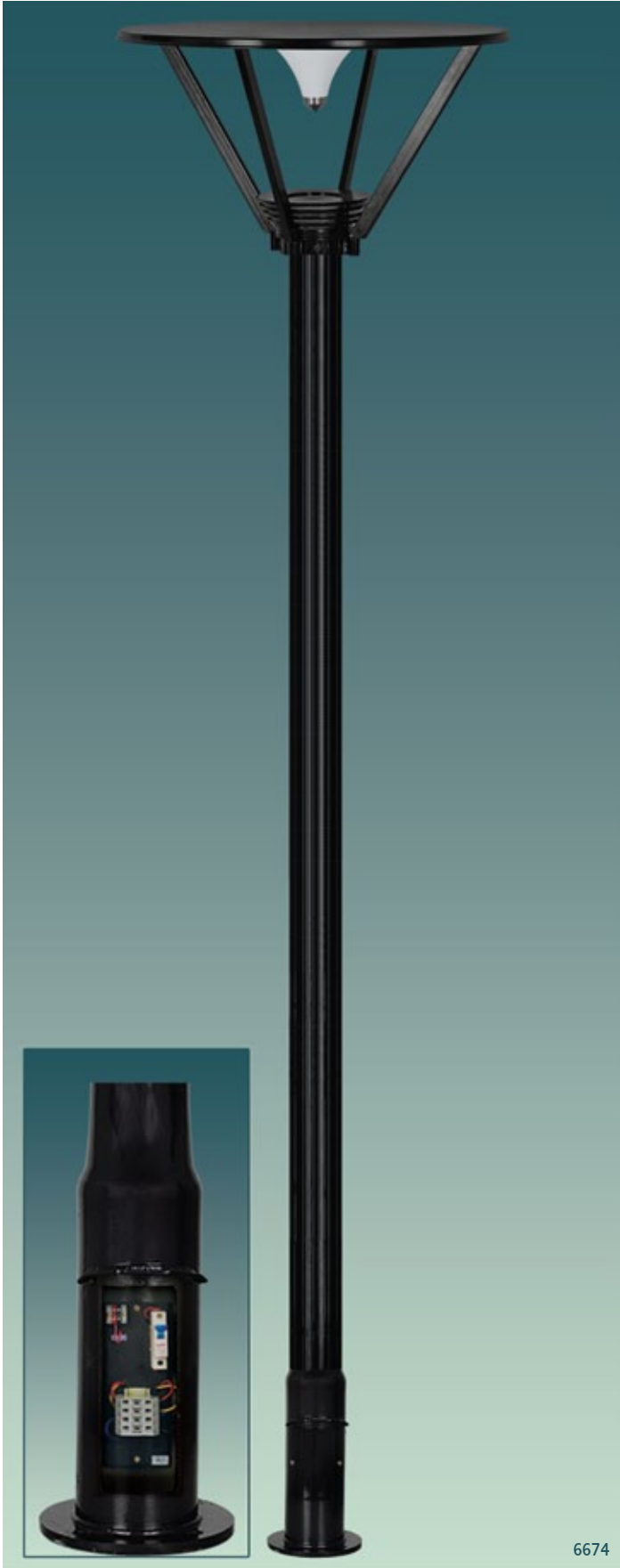

6674

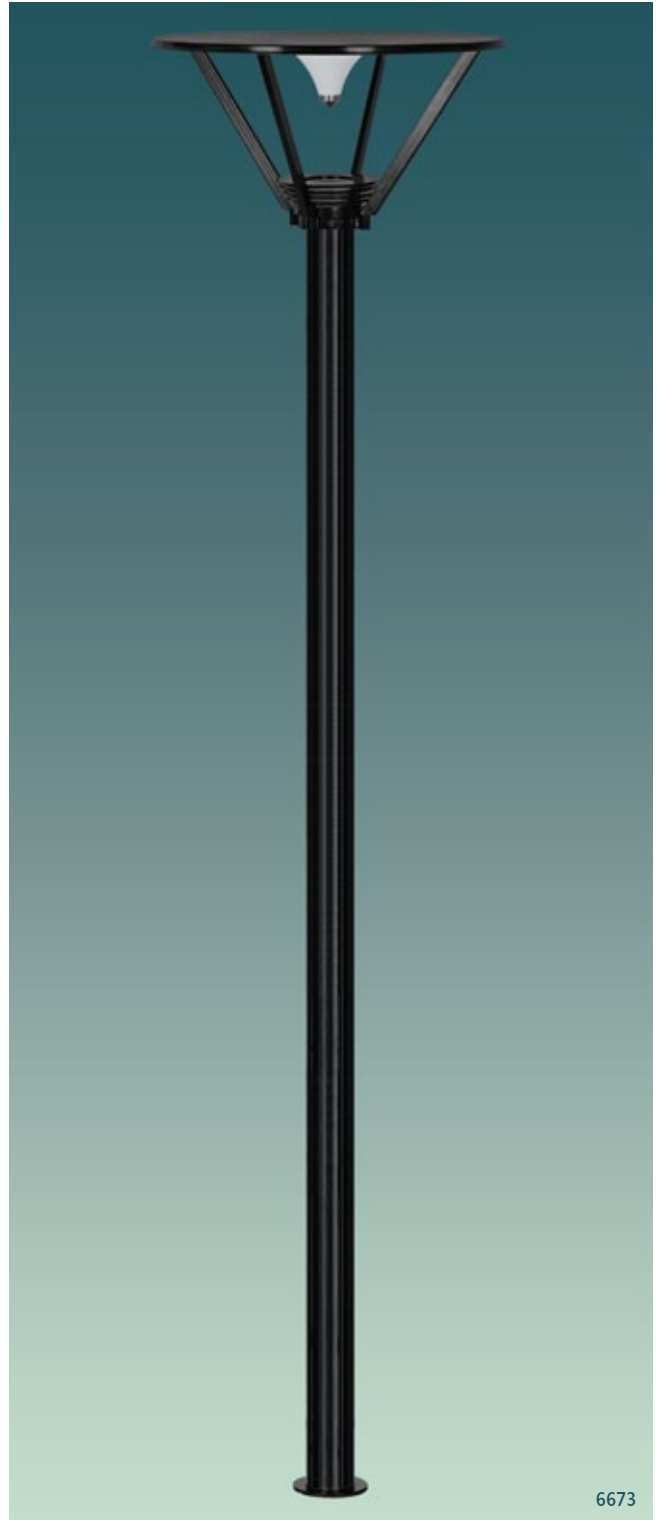

6673

NOTE : ⚡ Supplied with super imposed Ignitor. Ⓢ Mounting Details as per Fig. - 15 in Page No. F2. Ⓢ Mounting Details as per Fig. - 6 in Page No. F1.

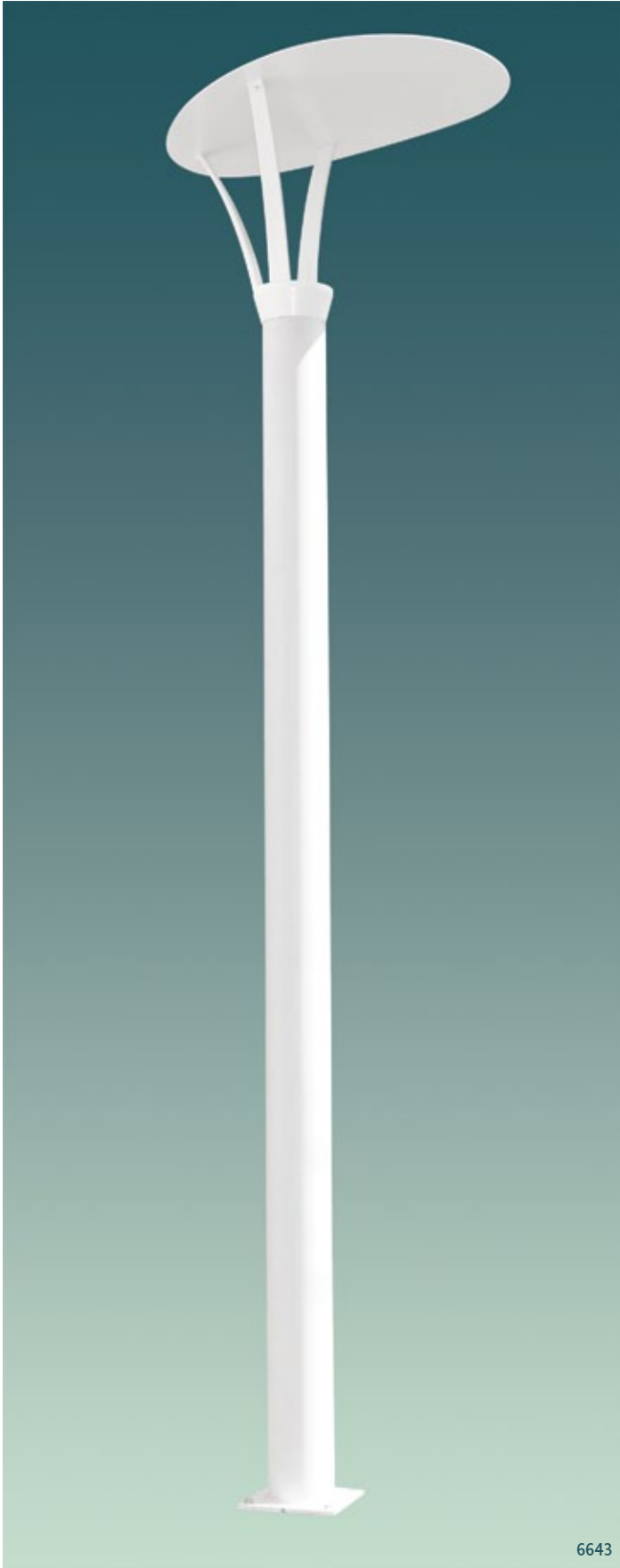

6643

ID	DESCRIPTION	DIMENSION mm	PRICE Rs.
ANGLE DIXON			
6643	Single 150W MH Lamp Integral with Satellite Pole	785 x 905 x 3000	59600/-

NOTE : ♦ Supplied with super imposed Ignitor. MH : Metal Halide. Ⓜ Mounting Details as per Fig. - 20 in Page No. F2.



4011

ID	DESCRIPTION	DIMENSION mm	PRICE Rs.
FLEMINGO			
4011	⊗ Twin 150W Metal Halide E27 Base Lamp Integral ⋄	Ht. 3660 (12')	82340/-

NOTE : ⋄ Supplied with super imposed Ignitor. ⊗ Mounting Details as per Fig. - 21 in Page No. F2.

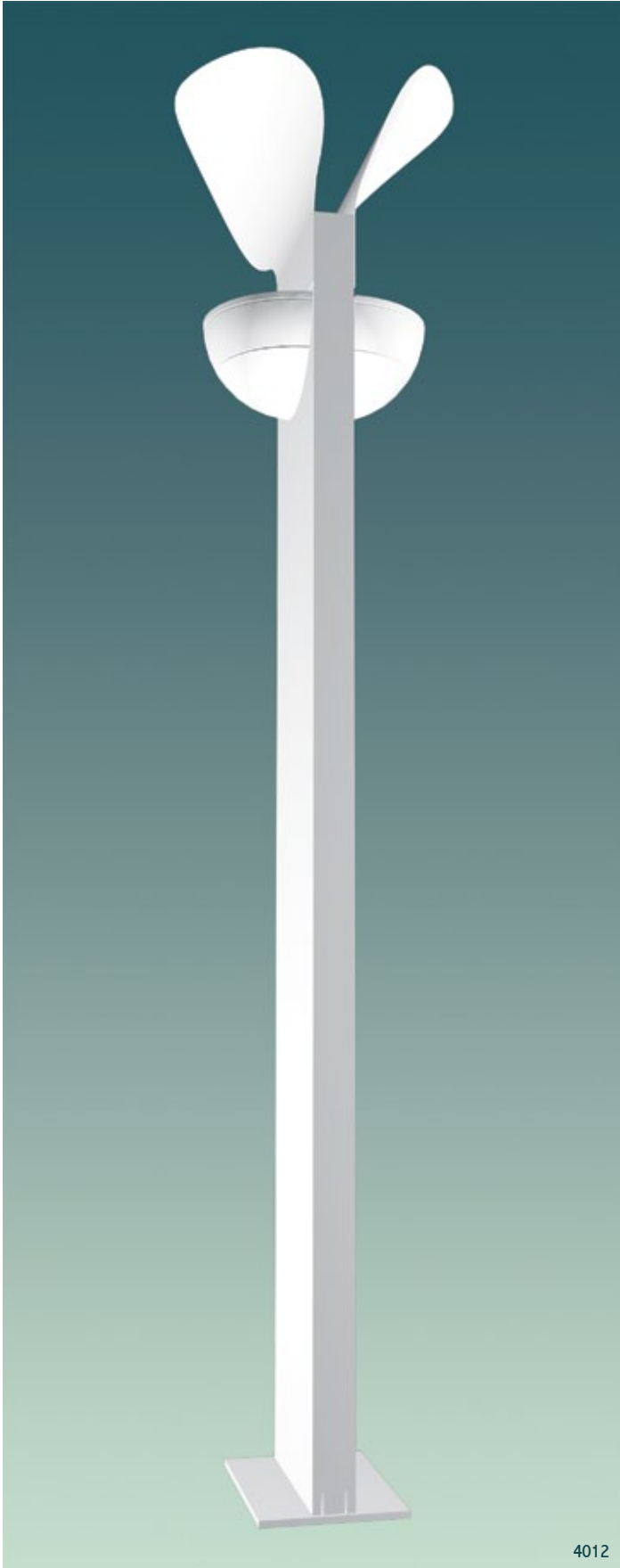

4012

ID	DESCRIPTION	DIMENSION mm	PRICE Rs.
NAJA			
4012	⊗ Twin 150W Metal Halide E27 Base Lamp Integral ⚡	Ht. 3660 (12')	79800/-

NOTE : ⚡ Supplied with super imposed Ignitor. ⊗ Mounting Details as per Fig. - 22 in Page No. F2.

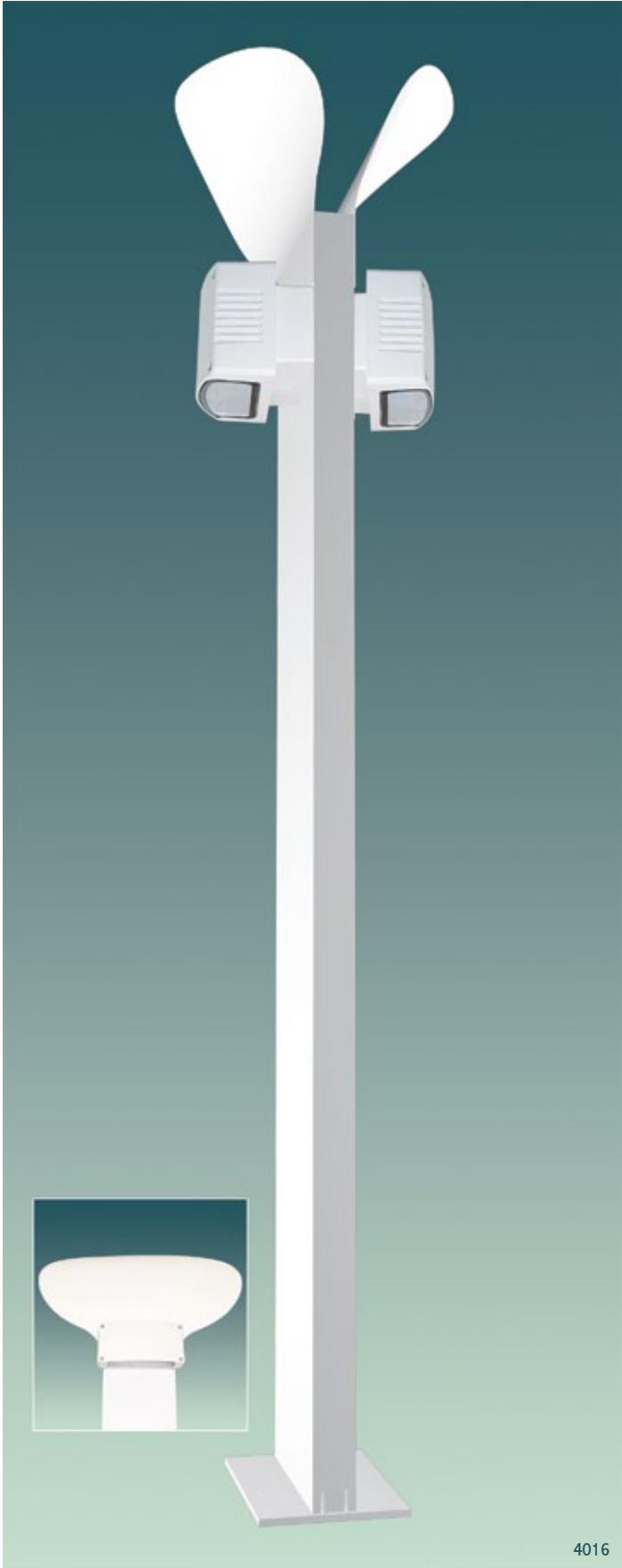

ID	DESCRIPTION	DIMENSION mm	PRICE Rs.
NAJA NIVEA			
4016	⊗ Twin 70W Metal Halide E27 Base Lamp Integral ⚡	Ht. 3660 (12')	57640/-

NOTE : ⚡ Supplied with super imposed Ignitor. ⊗ Mounting Details as per Fig. - 22 in Page No. F2.

ID	DESCRIPTION	DIMENSION mm	PRICE Rs.
WINGS			
4013	⊗ Twin 70W Metal Halide E27 Base Lamp Integral ✦	Ht. 3660 (12')	37920/-

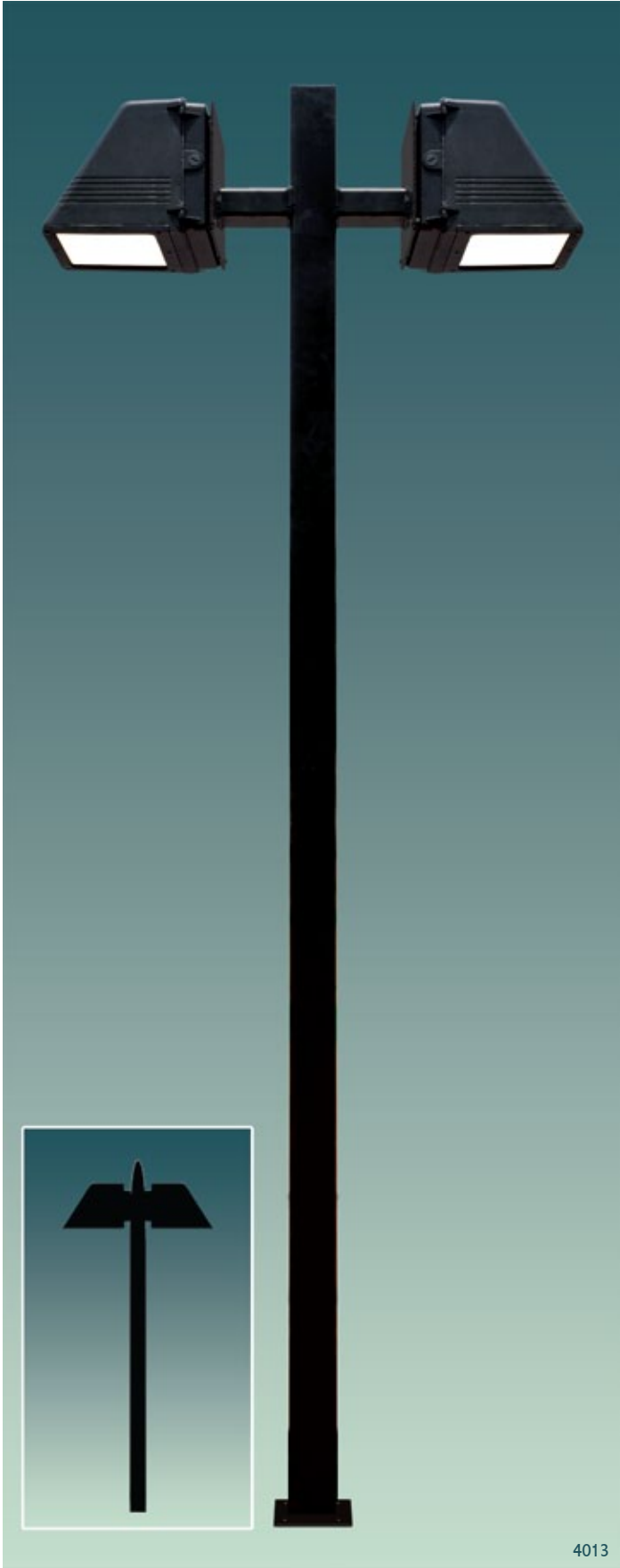

NOTE : ✦ Supplied with super imposed Ignitor. ⊗ Mounting Details as per Fig. - 29 in Page No. F3.

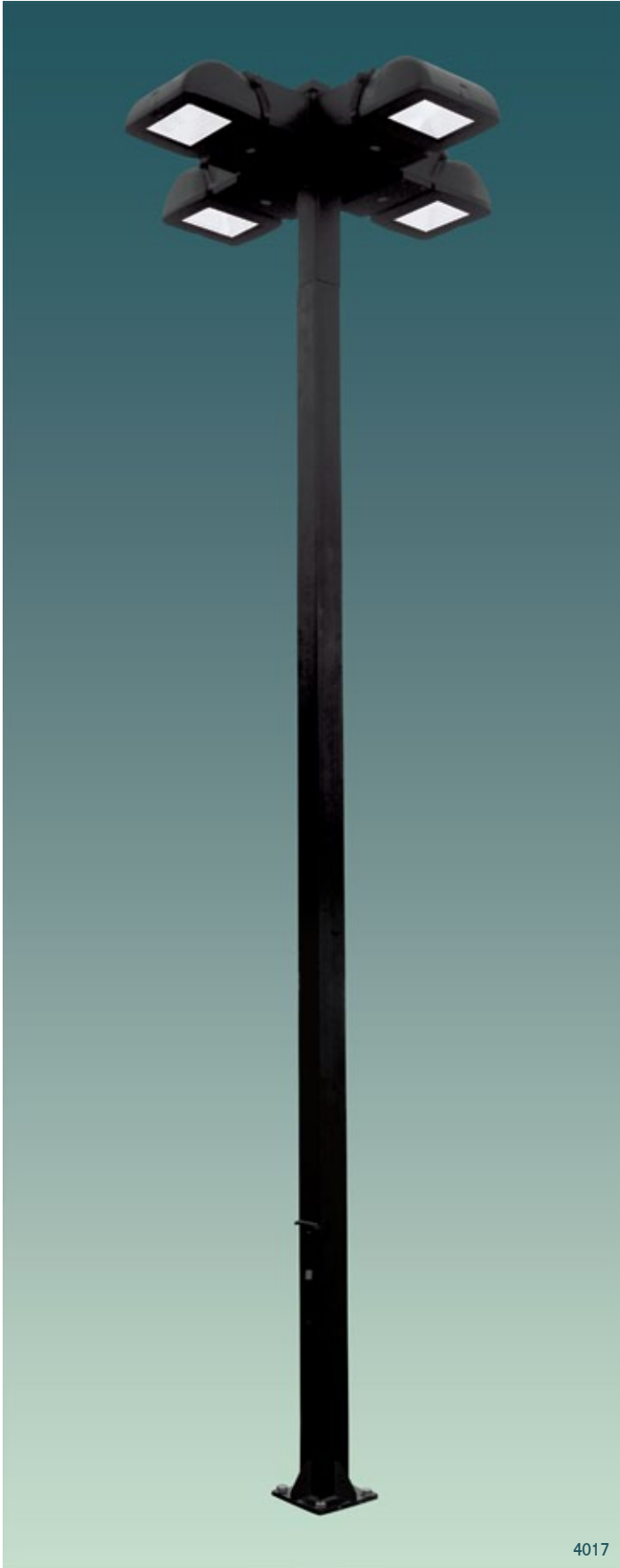

ID	DESCRIPTION	DIMENSION mm	PRICE Rs.
SWASTIK MAST			
4017	Ⓜ Four 150W Metal Halide E27 Base Lamp Integral ⚡	Ht. 6100 (20')	99980/-
4015	Ⓜ Four 400W Metal Halide E40 Base Lamp Integral ⚡	Ht. 10000 (33')	206000/-

NOTE : ⚡ Supplied with super imposed Ignitor. Ⓜ Mounting Details as per Fig. - 30 in Page No. F3. Ⓜ Mounting Details as per Fig. - 31 in Page No. F3.

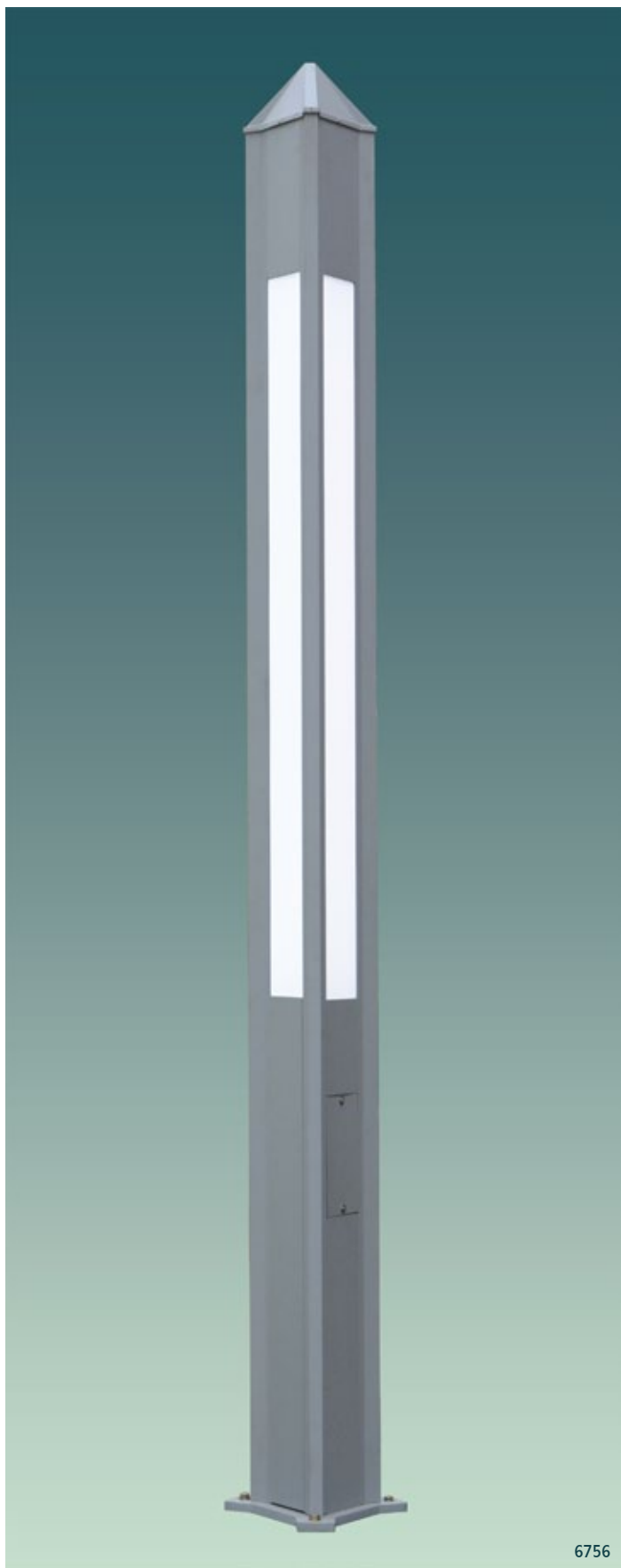

ID	DESCRIPTION	DIMENSION mm	PRICE Rs.
TRIGON			
6756	⊗ Twin 54W T-5 FTL	Ht. 3000	62220/-

NOTE : FTL : Fluorescent Tubular Lamp. ⊗ Mounting Details as per Fig. - 25 in Page No. F3.



6753

ID	DESCRIPTION	DIMENSION mm	PRICE Rs.
TANWIR			
6753	⊗ Twin 54W T-5 FTL & Single 70W MH E27 Base Lamp Integral ⊕	320 x 230 x 3500	58380/-

NOTE : ⊕ Supplied with super imposed Ignitor. FTL : Fluorescent Tubular Lamp. ⊗ Mounting Details as per Fig. - 26 in Page No. F3. MH : Metal Halide.



ID	DESCRIPTION	DIMENSION mm	PRICE Rs.
LIGHT COLUMN			
6650	Ⓢ Four 28W T-5 FTL Integral Galvanized Iron	Ø 165 x 2745	22600/-
6652	Ⓢ Four 54W T-5 FTL Integral Galvanized Iron	Ø 165 x 2745	24600/-
6646	Ⓢ Four 28W T-5 FTL Integral Stainless Steel	Ø 165 x 2745	34600/-
6647	Ⓢ Four 54W T-5 FTL Integral Stainless Steel	Ø 165 x 2745	36600/-

NOTE : Ⓢ Mounting Details as per Fig. - 2 in page No. F1. FTL : Fluorescent Tubular Lamp.



6651

ID	DESCRIPTION	DIMENSION mm	PRICE Rs.
LIGHT COLUMN			
6651	⊗ Single 150W MH G12 base Lamp Integral SS ✦	∅ 165 x 5000	77360/-

NOTE : ⊗ Mounting Details as per Fig. - 2 in page No. F1. ✦ Supplied with super imposed Ignitor. MH : Metal Halide. SS : Stainless Steel.

ID	DESCRIPTION	DIMENSION mm	PRICE Rs.
MEXICAN METRO - ENSY WITH LOOPIN LOOPOUT BOX			
6692	⊗ Four 14W T-5 FTL Integral	Ø 606 x 3000	46790/-
MEXICAN METRO - ENSY			
6693	⊗ Four 14W T-5 FTL Integral	Ø 606 x 3000	40790/-



NOTE : FTL : Fluorescent Tubular Lamp. ⊗ Mounting Details as per Fig. - 16 in page No. F2.

ID	DESCRIPTION	DIMENSION mm	PRICE Rs.
JERSEY WITH LOOPIN LOOPOUT BOX			
6688	⊗ Single 70W MH G12 Base Lamp Integral ⚡	Ø 606 x 3000	46790/-
JERSEY			
6689	⊗ Single 70W MH G12 Base Lamp Integral ⚡	Ø 606 x 3000	40790/-



6688

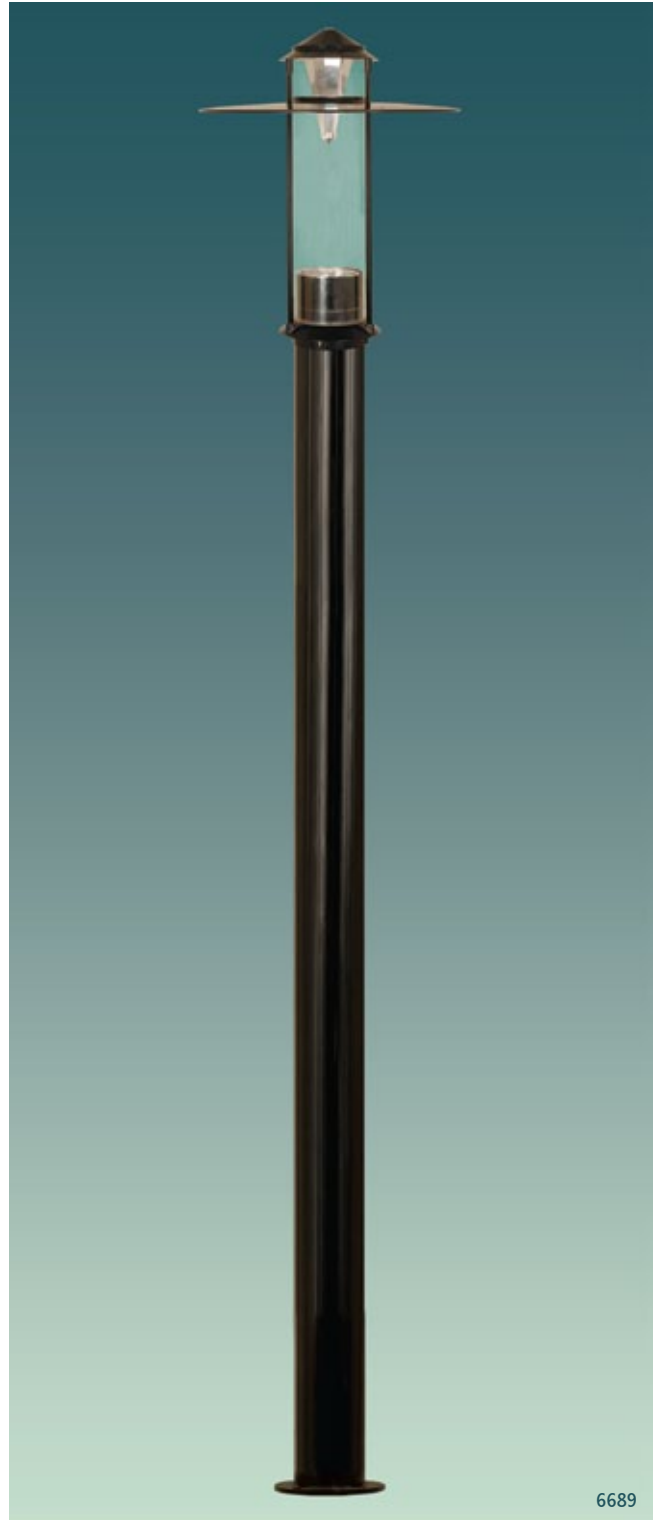

6689

NOTE : MH : Metal Halide. ⚡ Supplied with super imposed Ignitor. ⊗ Mounting Details as per Fig. - 16 in page No. F2.

ID	DESCRIPTION	DIMENSION mm	PRICE Rs.
MEXICAN METRO - VINCI WITH LOOPIN LOOPOUT BOX			
6686	⊗ Single 70W MH E27 Base Lamp Integral ✦	Ø 410 x 3000	44790/-
MEXICAN METRO - VINCI			
6687	⊗ Single 70W MH E27 Base Lamp Integral ✦	Ø 410 x 3000	38790/-



NOTE : MH : Metal Halide. ✦ Supplied with super imposed Ignitor. ⊗ Mounting Details as per Fig. - 16 in page No. F2.

ID	DESCRIPTION	DIMENSION mm	PRICE Rs.
MEXICAN ONSY WITH LOOPIN LOOPOUT BOX			
6694	⊗ Four 14W T-5 FTL Integral	Ø 175 x 3000	46790/-
MEXICAN ONSY			
6695	⊗ Four 14W T-5 FTL Integral	Ø 175 x 3000	40790/-



6694

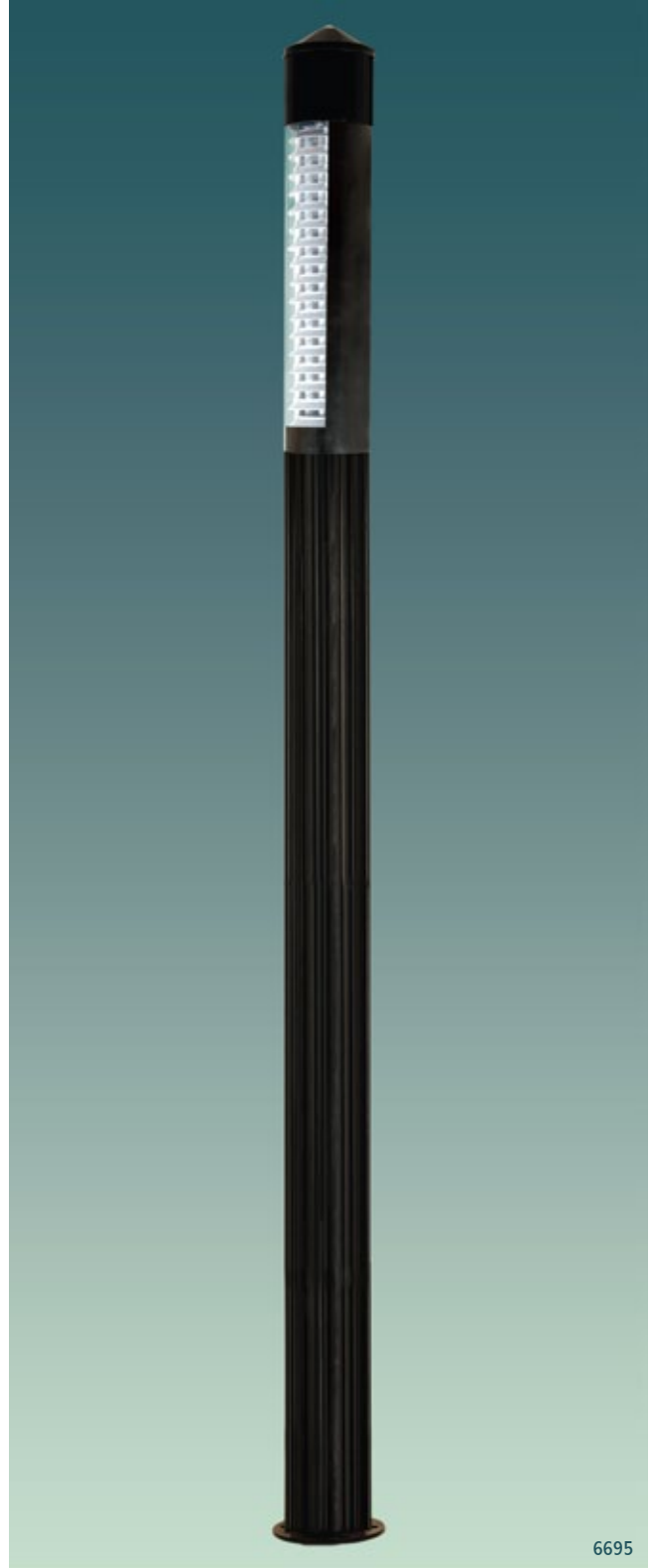

6695

NOTE : FTL : Fluorescent Tubular Lamp. ⊗ Mounting Details as per Fig. - 16 in Page No. F2.



ID	DESCRIPTION	DIMENSION mm	PRICE Rs.
BEETAL			
4001	⊗ Twin 26W CFLC Integral	Ht. 1000	23740/-
4002	⊗ Single 70W MH E27 Base Lamp Integral ✦	Ht. 1000	25600/-
4003	⊗ Four 26W CFLC Integral	Ht. 1000	30980/-
4004	⊗ Twin 70W MH E27 Base Lamp Integral ✦	Ht. 1000	34700/-
4005	⊗ Single 26W CFLC Integral	Ht. 1000	16090/-
4006	⊗ Single 70W MH E27 Base Lamp Integral ✦	Ht. 1000	16920/-
4007	⊗ Twin 26W CFLC Integral	Ht. 1000	22580/-
4008	⊗ Twin 70W MH E27 Base Lamp Integral ✦	Ht. 1000	24240/-

NOTE : ✦ Supplied with super imposed Ignitor. CFLC : Compact Fluorescent Lamp Coupled. MH : Metal Halide. ⊗ Mounting Details as per Fig. - 27 in Page No. F3.

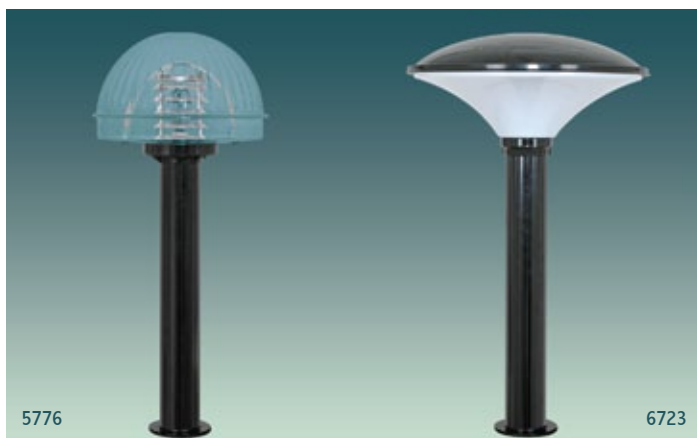

ID	DESCRIPTION	DIMENSION mm	PRICE Rs.
TUBE BOLLARD - LIGHT HOUSE			
5757	Ⓞ Four 11W CFL Light House Translucent	Ø 450 x 1120	8590/-
5758	Ⓞ Four 11W CFL Light House Louvre Clear	Ø 450 x 1120	9210/-
TUBE BOLLARD - SATURN			
5773	Ⓞ Four 11W CFL Saturn Midi Integral Translucent	Ø 430 x 990	8530/-
TUBE BOLLARD - PRINCE ORNA			
5774	Ⓞ Single 18W CFLC Prince Orna Integral Translucent	Ø 290 x 1040	7420/-
TUBE BOLLARD - HELMET			
5776	Ⓞ Single 70W MH E27 Base Lamp Helmet Integral ⚡	Ø 430 x 990	12320/-
TUBE BOLLARD - SHAMIANA			
6723	Ⓞ Single 70W (I) HPSV E27 Base Lamp ⚡ Ⓞ Shamiana Integral Translucent	Ø 590 x 965	9020/-
TORTOISE			
5601	Ⓞ Single 18W CFLC Integral Diffuser ❌	Ø 335 x 875	4880/-
MINI RING LANTERN			
5602	Ⓞ Single 18W CFLC Integral Louvre Clear ❌	Ø 355 X 1000	7420/-

NOTE : CFL : Compact Fluorescent Lamp. CFLC : Compact Fluorescent Lamp Coupled. HPSV : High Pressure Sodium Vapour Lamp.
 MH : Metal Halide. ⚡ Supplied with super imposed Ignitor. ⚡ For External Ignitor to suit SV lamp add Rs. 740/- Ⓞ Mounting Details as per Fig. - 5 in Page No. F1.
 Ⓞ Mounting Details as per Fig. - 7 in Page No. F1. Ⓞ Mounting Details as per Fig. - 8 in Page No. F1. Ⓞ Suitable for lamp with built-in Ignitor.
 ❌ Rates offered are inclusive of poles and brackets.

ID	DESCRIPTION	DIMENSION mm	PRICE Rs.
----	-------------	-----------------	--------------



LANDSCAPE LUMINAIRES

6604	Single 60W Reflector Lamp (NR63) Portable	Ø 100 x 180 x 370	740/-
6606	Single 60W Reflector Lamp (NR63) Bracket	Ø 100 x 180 x 150	790/-



6605	Single 100W Reflector Lamp (R95) Portable	Ø 150 x 200 x 420	820/-
6607	Single 100W Reflector Lamp (R95) Bracket	Ø 150 x 200 x 225	870/-



6609	Single 100W PAR 30 E27 Base Lamp Portable	Ø 98 x 155 x 360	740/-
6610	Single 100W PAR 30 E27 Base Lamp Bracket	Ø 98 x 155 x 165	790/-

NOTE : NR63 : Internal Mirror Coated Lamp. R95 : Internal Mirror Coated Lamp. PAR : Parabolic Aluminized Reflector Lamp.

ID	DESCRIPTION	DIMENSION mm	PRICE Rs.
----	-------------	-----------------	--------------

WALK OVER LUMINAIRES



6462	Single 240V 50W Halogen GU10 Base Lamp Two Way	Ø 105 x 140	2040/-
------	--	-------------	--------



6463	Single 240V 50W Halogen GU10 Base Lamp Four Way	Ø 105 x 140	2040/-
------	---	-------------	--------

DRIVE OVER LUMINAIRES

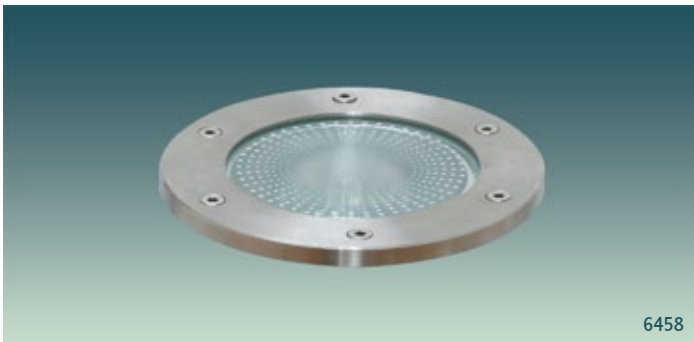

6458	Single 50W PAR 20 E27 Base lamp	Ø 165 x 210	6080/-
6461	Single 100W PAR 30 E27 Base lamp	Ø 210 x 235	7760/-



6459	Single 70W MH G12 Base Lamp Integral ⚡ ⓧ	Ø 250 x 290	12840/-
------	--	-------------	---------



6454	Single 70W MH DE Lamp Integral ⚡ ⓧ	Ø 240 x 300	12840/-
------	------------------------------------	-------------	---------

NOTE : MH : Metal Halide. DE : Double Ended. PAR : Parabolic Aluminized Reflector Lamp. ⓧ Separate control gear box if desired, can be given at extra cost on request.
⚡ Supplied with super imposed Ignitor.